



ACROBATIC  
PARKS 2017



[WWW.KONG.IT](http://WWW.KONG.IT)

This catalog is aimed at managers and builders of acrobatic parks and is composed of two parts:

- the first relates to complex components and systems for the construction of the parks;
- the second is an excerpt from our range of PPE (helmets, harnesses, connectors, pulleys...) specific for this activity.

Being manufacturers, the high quality standards guaranteed by "Made in Italy" production and the assistance of our staff, allow us to meet everyone's needs and provide customized solutions.

Questo catalogo è rivolto ai gestori e/o costruttori di parchi avventura ed è strutturato in due parti:

- la prima è composta da sistemi e componenti complessi per la costruzione dei parchi;
- la seconda è un estratto della nostra gamma di DPI (caschi, imbracature, connettori, carrucole...) specifici per questa attività.

Il fatto di essere produttori, gli elevati standard qualitativi del "made in Italy" e l'assistenza del nostro personale, ci permettono di soddisfare le esigenze più disparate e di fornire soluzioni "ad hoc".



SYSTEMS AND COMPONENTS  
SISTEMI E COMPONENTI



PPE KIT  
KIT DPI



INDEX  
INDICE

COUDOU PRO	p. 3
FLY-LINE	p. 8
HELMETS / CASCHI	p. 10
HARNESSES / IMBRACATURE	p. 10
GLOVES / GUANTI	p. 11
PULLEYS / CARRUCOLE	p. 12
CONNECTORS / CONNETTORI	p. 13
SLINGS / FETTUCCE	p. 14
EVACUATION KIT / KIT EVACUAZIONE	p. 14

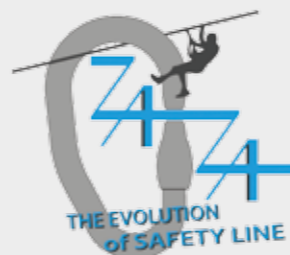

Watch the video  
Guarda il video

HOW IT WORKS?

The principle of operation is very simple: the opening of the hook is smaller than the diameter of the cable but greater than the thickness of the plates. In this way the safety is guaranteed, once you enter the lifeline is impossible to get out before the end of the course. Only by a special key supplied to the manager of the park is it possible to unlock the sleeve and then make ultra-rapid evacuations in case of illness, storm, fire, etc...

Thanks to the various components it is possible to secure all steps and various games of your park, as the liana jump with the new ZAZA 2 Connect. Coudou Pro system will allow you to save on surveillance staff costs, ensuring better security for your customers.

COME FUNZIONA?

Il principio di funzionamento è molto semplice: l'apertura del gancio è inferiore al diametro del cavo ma superiore allo spessore delle piastre di raccordo. In questo modo la sicurezza è garantita, una volta entrati nella linea vita è impossibile uscirne prima della fine del percorso. Solo tramite la speciale chiavetta data in dotazione al gestore del parco è possibile sbloccare la ghiera e quindi effettuare rapidamente l'evacuazione in caso di malore, temporale, incendio, ecc...

Grazie ai vari componenti è possibile mettere in sicurezza tutti i passaggi e i vari giochi del vostro parco, anche il salto con liana grazie al nuovo ZAZA 2 Connect per il salto verticale. Il sistema Coudou Pro vi permetterà di risparmiare sui costi del personale addetto alla sorveglianza, garantendo maggiore sicurezza ai vostri clienti.

ZAZA2 CS

ADULTS

- The only hook on the market equipped with an ultra fast evacuation system. No maintenance, simple mechanism, very low price compared to traditional safety systems. Best classification (class E PAH norms) for max safety that allow to save money on insurance costs.

- L'unico connettore in commercio dotato di sistema ultra-rapido per l'evacuazione. Meccanismo di funzionamento molto semplice, nessuna manutenzione, prezzo veramente ridotto rispetto ai sistemi tradizionali. Miglior classificazione (classe "E" secondo le norme PAH) per la massima sicurezza che permette di risparmiare sulla quota assicurativa.



ZAZA CLE

OPERATOR

- Safety key for the opening of the hooks in case of evacuation; for operator only.

- Chiave di sicurezza per l'apertura del gancio in caso di evacuazione; fornita solo agli operatori.

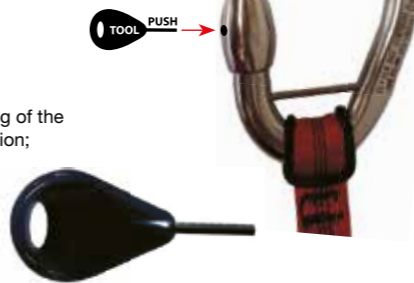

--	--	--	--	--	--

ADULTS  
ADULTI

ZAZA2 PLS3

ADULTS

- Plate for new paths and games, easy to install with clamps.
- Piastra per nuovi percorsi e giochi, facile da installare tramite morsetti.

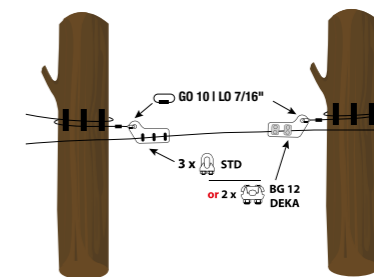
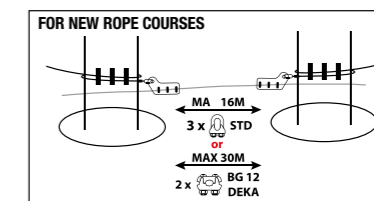

OPTION: PG3

- Replaces the washers and guides the hook.
- Sostituisce le rondelle e guida il connettore.



--	--	--	--	--

ZAZA2 PLS5

ADULTS

- Plate for zip line, easy to install with clamps, quick adjustment.
- Piastra per tirolenne, facile da installare tramite morsetti, regolazione rapida.

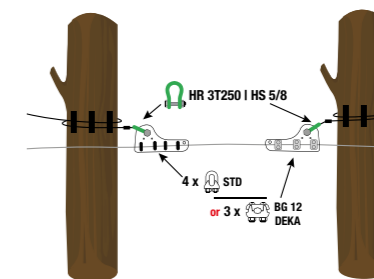
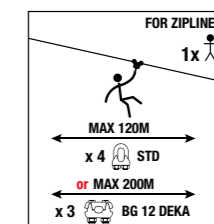

OPTION: PG5

- Replaces the washers and guides the hook.
- Sostituisce le rondelle e guida il connettore.



--	--	--	--	--

## ZAZA2 PLZ NEW

**ADULTS**

- More compact, easy to install, quick adjuster.
- Compatto, di facile installazione, regolazione rapida.

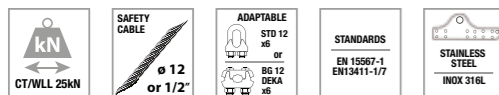
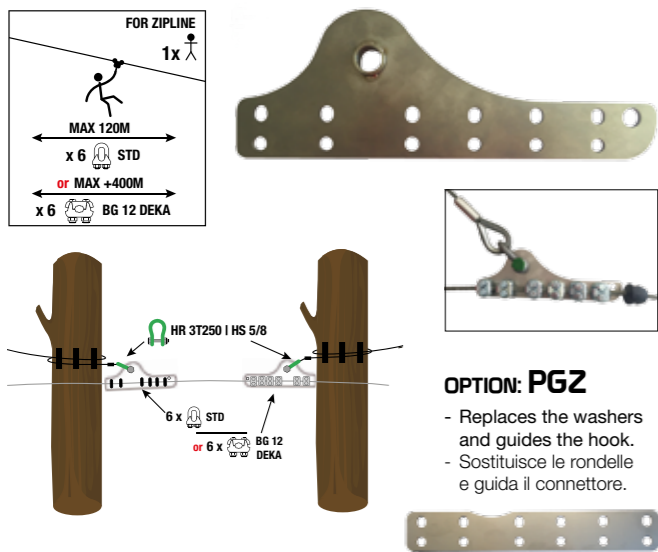

## ZAZA2 VIA

**ADULTS**

- Plate adaptable on rock and artificial structures, very easy to install with clamps.
- Piastra per strutture artificiali e roccia, veramente facile da installare tramite morsetti.

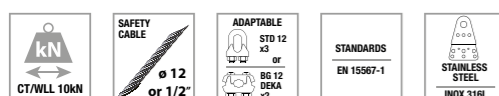
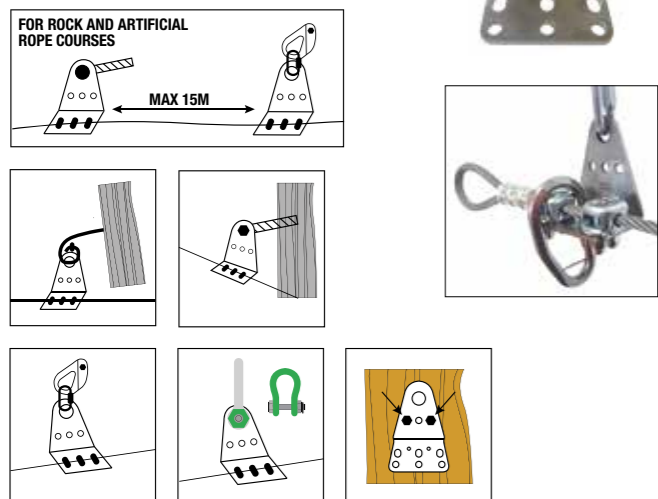

## ZAZA2 DELTA NEW

**ADULTS**

- Special for artificial structure, realize bends from 0° to 270°. High flexibility.
- Per strutture artificiali, permette curve da 0° a 270°. Alta flessibilità.

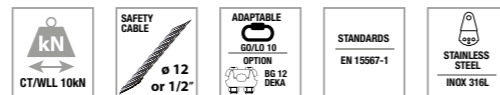
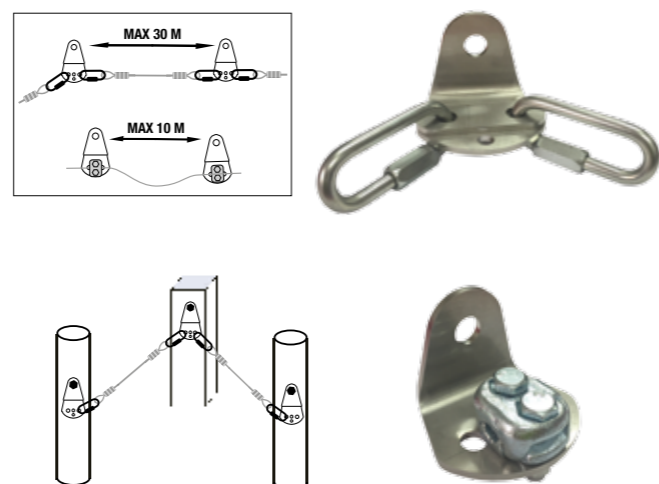

## ZAZA2 PLI

**ADULTS**

- Plate adaptable on existing paths without modification, very easy to install with clamps.
- Piastra per giochi e percorsi esistenti, veramente facile da installare tramite morsetti.

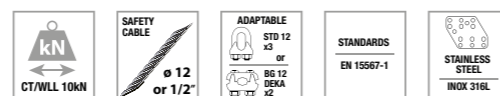
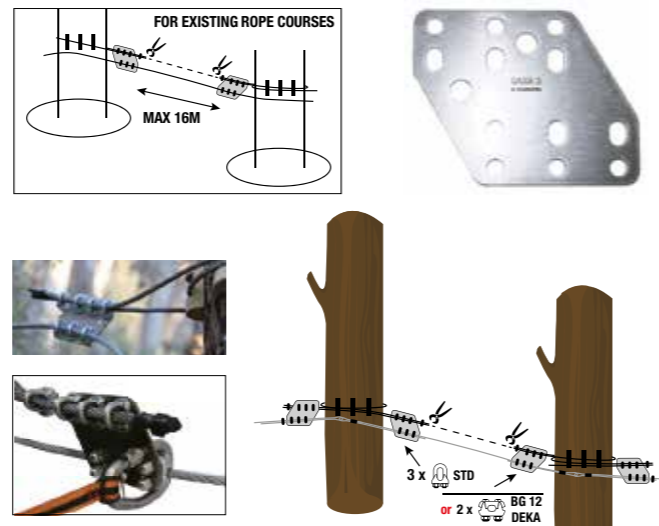

## ZAZA2 STOP

**ADULTS**

- Rubber pad for securing the vertical passages and absorb the shocks at the end of zip line.
- Tampone in gomma per mettere in sicurezza i passaggi verticali e ammortizzare il fine corsa delle tirolienne.

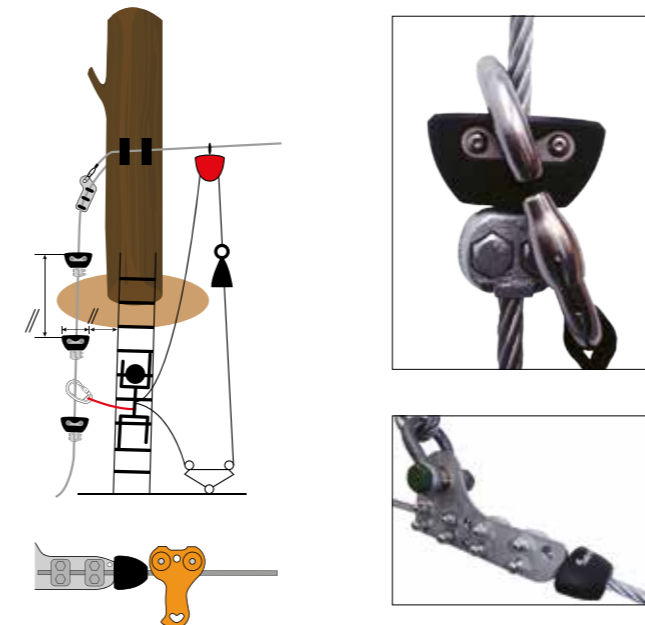

## ZAZA2 PC NEW

**ADULTS**

- Holds the lifeline at desired height Adaptable on existing ropes courses without modification. Very easy and simple to install.
- Mantiene la linea vita all'altezza desiderata. Adattabile a percorsi già esistenti senza apportare modifiche. Molto semplice da installare.

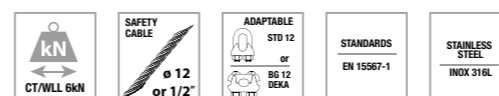

## ZAZA2 PAIG

**ADULTS**

- Exchange plate for escape, bifurcations or overtaking.
- Piastra di scambio per vie di fuga, biforcazioni o sorpassi.

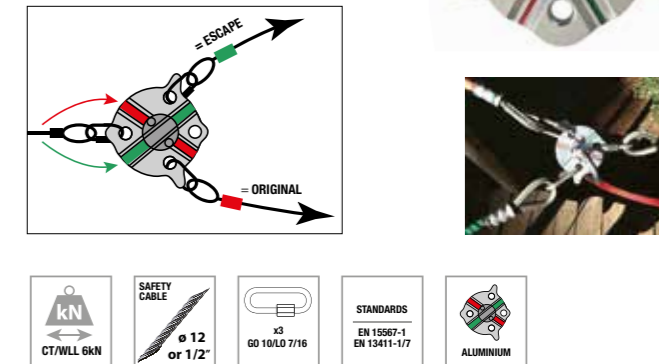

## ZAZA2 CONNECT 2.0 NEW

**ADULTS**

- Vertical jump device for liana, skateboard and all the others games where the disconnection from the lifeline is needed. It allows to stay in complete safety with a simple and intuitive system. New version with hard anodization for the maximum wear resistance.
- Innovativo dispositivo per il salto verticale. Concepito per liane, skateboard e tutti i giochi dove è richiesta la disconnessione dalla linea vita. Permette di restare in completa sicurezza con un sistema semplice e intuitivo. Nuova versione con anodizzazione dura che garantisce la massima resistenza all'usura.

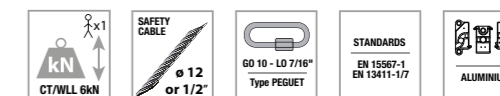
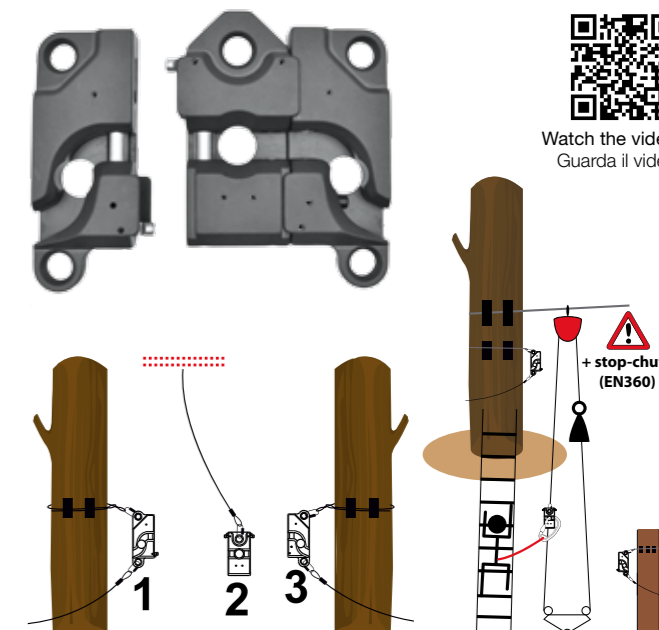

WITHOUT CLAMPS  
SENZA MORSETTI

ZAZA2 PBJ (PATENTED)

ADULTS

- Plate for paths and games, easy to install NO CLAMP, NO MAINTENANCE!
- Piastra per nuovi percorsi e giochi, facile da installare SENZA MORSETTI, SENZA MANUTENZIONE!

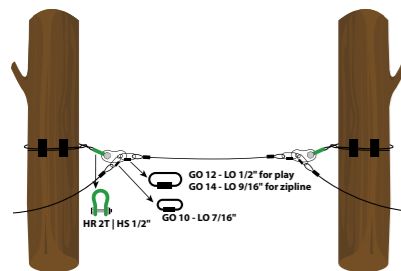
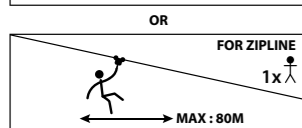
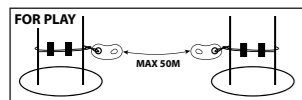

RESISTANCE 84kN	CT/WLL 15kN	ø 12 or 1/2"		ACCT EN 15567-1 EN 13411-1/7	INOX 316L
-----------------	-------------	--------------	--	------------------------------	-----------

ZAZA2 PBT (PATENTED)

ADULTS

- Plate for zip line, easy to install, quick adjustment, NO CLAMP, NO MAINTENANCE!
- Piastra per tirolienne, facile da installare, regolazione rapida, SENZA MORSETTI, SENZA MANUTENZIONE!

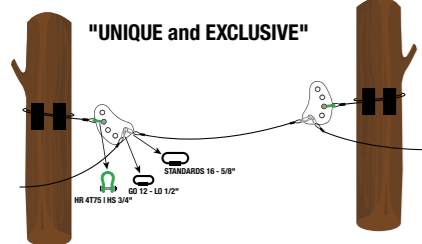
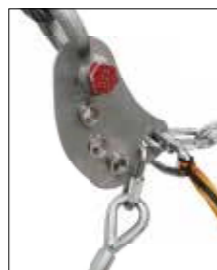
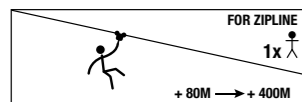

RESISTANCE 101kN	CT/WLL 30kN	ø 12 or 1/2"		ACCT EN 15567-1 EN 13411-3	INOX 316L
------------------	-------------	--------------	--	----------------------------	-----------

KIDS  
BAMBINI

ZAZA CS (FOR KIDS) CE

KIDS

- Hook for children. It keep the same features of adults version but works only on paths for children with cable diameter 10mm.
- Gancio per bambini. Conserva le stesse caratteristiche di quello per adulti ma funziona solo sui percorsi idonei per i più piccoli con cavo diametro 10mm.



ZAZA CLE

OPERATOR

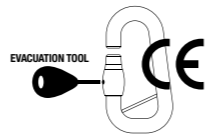

CT/WLL 15kN	ø 10 or 3/8"		NORMES EPI 88-086-02 RPI 11-104 EN 15567-1-2	INOX ø12
-------------	--------------	--	--	----------

ZAZA PLI = FOR PLAY

KIDS

- Kids plate adaptable on existing paths without modification, very easy to use for children.
- Piastra per bambini per giochi e percorsi esistenti, veramente facile da utilizzare.

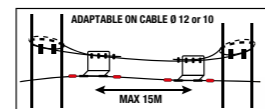

CT/WLL 6kN	ø 10	STD x3 ø12 or 10	EN 15567-1 EN 13411-1/7	INOX 316L
------------	------	------------------	-------------------------	-----------

ZAZA PLT = FOR ZIPLINE

KIDS

- Kids plate for zip line adaptable on existing paths without modification, very easy to use for children.
- Piastra per bambini per tirolienne adattabile a percorsi esistenti, veramente facile da utilizzare.

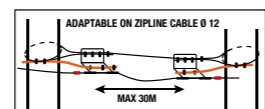

CT/WLL 6kN	ø 10	STD x4 ø12	EN 15567-1 EN 13411-1/7	INOX 316L
------------	------	------------	-------------------------	-----------

ACCESSORIES  
ACCESSORI

TALUGRIP ALUMINIUM FERRULES

- Aluminum ferrules for Zaza2 safety system; developed with GERRO Company a special ferrule of 70 mm for adventure park which allows to answer in requirement of the standard (4 crimps and cover the dead end of the rope).
- Boccole in alluminio per il sistema di sicurezza Zaza2; sviluppata con la società Gerro una boccola di 70 mm specifica per i parchi avventura, che permette di rispondere ai requisiti dello standard (4 tacche e copertura della parte terminale del cavo).



Press for crimping tool



STAINLESS FERRULES  
FOR ZAZA SAFETY SYSTEM

- Specials ferrules for children rope courses. More compact, more fluidity, speed of implementation, professional visual aspect.
- Boccole specifiche per i percorsi da bambini. Compatte, aumentano la fluidità, la velocità di implementazione e l'aspetto del percorso.

Crimping ferrule  
Boccole da crimpare



Start and arrival ferrules  
Boccole terminali



Connecting sleeve for life line  
Boccole di connessione



CT/WLL 6kN	ø 10	EN 15567-1 EN 13411-1/7	INOX 303
------------	------	-------------------------	----------

ZAZA2 BLOCK NEW

- Allows to realize a binding on a horizontal or angled cable. Protect the longevity of support ropes. Professional visual aspect.
- Permette di realizzare un ancoraggio su un cavo orizzontale o inclinato. Protegge la longevità dei cavi di sostegno e dona un aspetto ordinato e professionale.

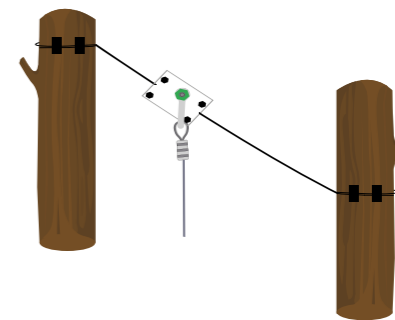

ø 12 or 1/2"	Bow shackles	EN 15567-1 EN 13411-1/7	
--------------	--------------	-------------------------	--

ZAZA2 BG NEW

- Wire clamp BG double nuts for plates: PLS3, PLI, PLS5, PLZ, VIA, DELTA, VSTOP. Ergonomic shape for more fluidity. Doesn't damage the wire. Easy installation for the maximum safety. Removal of the dead end of the rope. Massive design for the maximum robustness during the use.



- Morsetto con doppi dadi per le piastre PLS3, PLI, PLS5, PLZ, VIA, DELTA, VSTOP. Forma ergonomica per una maggiore fluidità. Non danneggia il cavo. Facile installazione, massima sicurezza. Permette la rimozione dei terminali del cavo. Robustezza d'uso grazie alla forma massiccia.

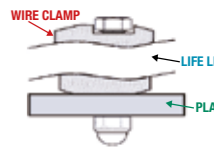

ZAZA2 MULTI

- Multifunction tool for operators.
- Attrezzo multifunzione per operatori.

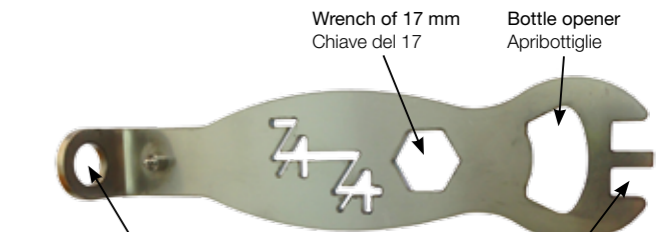

Evacuation tool for safety hook  
Chiave di evacuazione per il connettore

Evacuation tool for Connect  
Chiave di evacuazione per il Connect



**ENJOY A LOW-LEVEL FLIGHT THROUGH THE FOREST**

No engine noise, no other sounds - only the quiet buzzing of the brakes will accompany us on our flight. Now very close to the tree, the next second high up in the air and then back down almost brushing the forest floor!

The flight track Fly-Line meanders constantly changing through curves and loops, in turns and waves - just like you would be riding a mountain road down into the valley.

Quickly completed the last labyrinth and there already the runway is in sight.

Touch Down - a perfect landing.

Kong in collaboration with Fly-Line has developed and produces the special trolley, with brakes that limit the maximum speed to 12 km/h, which allows you to safely enjoy this new attraction.

**DIVERTITEVI CON UN VOLO A BASSA QUOTA TRA GLI ALBERI**

Nessun rumore di motori, ma solo il leggero sussurrare dei freni vi accompagnerà durante il vostro volo in mezzo alla natura. Prima in alto fra gli alberi, poi in basso quasi raso terra, poi di nuovo in alto serpeggiando con curve strette e larghe come su una strada di montagna.

Alla fine veloci attraverso l'ultimo labirinto e già si vede la dirittura di arrivo.

Touch down - un perfetto atterraggio.

Kong in collaborazione con Fly-Line ha sviluppato e produce lo speciale carrello, dotato di freni che ne limitano la velocità massima a 12 km/h, che permette di godersi in totale sicurezza questa nuova attrazione.



Watch the video  
Guarda il video



ph: parco Col De Flam, Ortisei (BZ)

**PPE KIT  
KIT DPI**



**KONG** presents the PPE KITS for users and operators, very appreciated for durability and reliability, successfully used since 2005 by thousands of users every year.

**MAIN FEATURES:**

The stresses that affect PPE KIT in an adventure park, where users are not experts, suggest not to use Klettersteig Set which do not take into account some very important factors for better management of this activity:

- high-cyclicalty of the components;
- reduction of dimensions for a better handling for children;
- versatility of each component of the set.

PPE KITS proposed in this catalog provide:

- substitution of single connectors without having to change the whole system
- connectors are not permanently attached to the lanyard
- longe are separated from the harness

**STANDARDS**

All components are manufactured in accordance with specific industry regulations and, where required, are CE marked.

Parco avventura La Turna Montestrutto Settimo Vittone (TO) - ph: Rossano Morello

**KONG** presenta i propri KIT DPI per UTENTI e OPERATORI, all'avanguardia per durata e affidabilità, impiegati con successo dal 2005 da decine di migliaia di utenti ogni anno.

**PRINCIPALI CARATTERISTICHE:**

Le sollecitazioni che un KIT DPI subisce nell'attività quotidiana in un Parco Avventura, dove gli utenti non sono degli esperti, suggeriscono di utilizzare Kit da Ferrata che tengano conto di alcuni fattori molto importanti per la miglior gestione di questa attività:

- forte ciclicità a cui sono sottoposti tutti i componenti;
- riduzione degli ingombri per una miglior manipolazione anche per i bambini;
- versatilità di ogni componente del set DPI.

I KIT DPI proposti in questo catalogo garantiscono:

- possibilità di sostituzione dei singoli connettori senza dover cambiare tutto;
- i connettori non sono agganciati permanentemente alle longe!
- le longe, a loro volta, sono separate dall'imbragatura!

**NORMATIVE**

Tutti i componenti sono realizzati nel rispetto delle specifiche normative di settore e, dove richiesto, sono provvisti di marchio CE.

HELMETS  
CASCHI

MOUSE

ADULTS KIDS EN 12492

- Sizes: Universal size (52-63 cm), for adults and children over 8 years old.
- On request, for suitable minimum quantities, we can assess custom colours and logos.
- Taglia Universale (52-63 cm), per adulti e bambini da 8 anni in su.
- Su richiesta, per quantitativi minimi idonei, è possibile valutare colori e loghi personalizzati.



White #99716AW02KK  
Red #99716AR02KK  
Black #99716AN02KK

HARNESSES  
IMBRACATURE

INDIANA

#8C0670000KK

ADULTS KIDS EN 12277

- Completely adjustable harness, with self-locking buckles.
- Universal size.
- Imbragatura completamente regolabile, con fibbie auto-bloccanti.
- Adatta per adulti e bambini.
- Taglia universale.



GOGO

#8C0150000KK

KIDS EN 12277/C

- New harness specifically conceived for children 90/135 cm height, max 40 kg.
- Universal size.
- Nuova imbragatura specifica per bambini di altezza 90/135 cm, massimo 40 kg.
- Taglia UNI.



GLOVES  
GUANTI

ALEX

ADULTS EN 388:2003 - EN 420:2003

- Three 3/4 cutted fingers, with Kevlar protection on the palm.
- Tre dita lunghezza 3/4, con protezione in Kevlar sul palmo.



#95201YWF2KK - S  
#95201YWF4KK - M  
#95201YWF6KK - L  
#95201YWF7KK - XL  
#95201YWF8KK - XXL  
#95201YWF9KK - XXXL

POP

KIDS EN 388:2003 - EN 420:200

- Five cutted fingers.
- Cinque dita tagliate.



#95202BN09KK - XS  
#95202BN02KK - S  
#95202BN03KK - M  
#95202BN04KK - L  
#95202BN05KK - XL  
#95202BN06KK - XXL

MOUSE WORK

OPERATOR EN 397

- Helmet for operator, comfortable and well ventilated with wheel adjustment system.
- Chinstrap designed to open in case of suspension to prevent choking: it opens between 15 and 25 daN (conform to CE EN 397 standard).
- Casco per operatori, resistente, confortevole e ben areato con sistema di regolazione a rotella.
- Sottogola progettato per aprirsi in caso di sospensione ed evitare il soffocamento: si apre tra i 15 e i 25 daN (norma caschi industria EN 397).



Red #99718AR02KK

INDIANA FULL

#8C0690000KK

ADULTS EN 12277

- Full body harness with fast buckles.
- Automatic buckle for the connection of the upper part.
- It fits both adults and children.
- Universal size.
- Imbragatura completa, con fibbie auto-bloccanti.
- Fibbia automatica per il collegamento della parte superiore.
- Adatta per adulti e bambini.
- Taglia universale.



TARGET PRO

OPERATOR EN 12277/A - EN 361 - EN 358 - EN 813

- Professional harness for operators and rescuers.
- Removable upper part, comfortable, light and breathable.
- Ultra-fast dressing.
- Imbragatura professionale per gli operatori e i soccorritori.
- Parte superiore amovibile comoda, leggera e traspirante.
- Vestizione ultra-rapida.

#8W9932000KK - S  
#8W9933000KK - M/L  
#8W9935000KK - XL



SKIN

OPERATOR EN 388:2003

- Gloves for operators with leather palm, breathable nylon back and rubber reinforced fingers.
- Available in 4 sizes from S to XL.
- Guanto per operatori con palmo in pelle, dorso in nylon traspirante e dita rinforzate in gomma.
- Disponibile in 4 taglie dalla S alla XL.



#95205N002KK - S  
#95205N004KK - M  
#95205N006KK - L  
#95205N007KK - XL

FULL

OPERATOR EN 388:2003 - EN 420:200

- Gloves for operators with reinforced Kevlar palm, breathable leather and nylon back.
- Available in 5 sizes from S to XXL.
- Guanto per operatori con palmo rinforzato in Kevlar, dorso in pelle scamosciata e nylon.
- Disponibile in 5 taglie dalla S alla XXL.



#95203YWF2KK - S  
#95203YWF4KK - M  
#95203YWF6KK - L  
#95203YWF7KK - XL  
#95203YWF8KK - XXL

**PULLEYS  
CARRUCOLE**

**ZIP EVO** #826040400KK

ADULTS KIDS OPERATOR EN 12278

- Innovative double pulley for cables up to 13 mm.
- Equipped with a gate that prevents any possibility of error during positioning. Anti-rollover system.
- Innovativa carrucola doppia per cavi fino a 13 mm.
- Dotata di pratica leva che garantisce una chiusura a prova di errore e un assetto anti-ribaltamento.



**ZIP EVO HOOK** #826050400KK

ADULTS KIDS EN 12278

- Special version of ZIP pulley with hook for the suspension of the connectors that avoids the wearing caused by the friction on metal cable.
- Versione speciale della carrucola ZIP con gancio per la sospensione dei connettori che evita lo sfregamento sul cavo d'acciaio aumentandone la durata.



**PAMIR FAST** #82600B400KK

ADULTS KIDS EN 12278

- Double pulley with ball bearings used for construction of the games (zip line for children, recovery of liana, skateboard, etc...).
- Carrucola doppia con cuscinetti a sfera utilizzata per la costruzione dei giochi (tirolienne bambini, recupero liane, skateboard, ecc...).

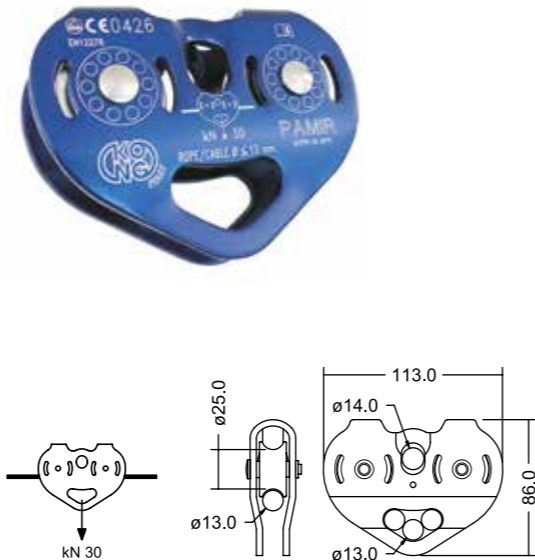

**CLACK** #223000000KK

ADULTS KIDS OPERATOR

- Patented system for fixing the pulley to the harness with a simply but ingenious magnet.
- Sistema brevettato, per fissare la carrucola all'imbracatura con un semplice ma geniale magnete.



**CONNECTORS  
CONNETTORI**

**ERGO EX** #7830001G1KK

EN 12275/K - EN 362/B 29 kN 10 kN 60 g

- Alu alloy connector, Key Lock system, automatic express sleeve.
- Connettore in lega d'alluminio, sistema Key Lock e ghiera automatica Express.



**ERGO WIRE** #907N003X3KK

EN 12275/K - EN 362/B 29 kN 10 kN 60 g

- Alu alloy connector, Key Lock system, double gate sleeve.
- Connettore in lega d'alluminio e ghiera automatica di sicurezza.



**CONNECTORS  
CONNETTORI**

**PADDLE** EN 12275

- Usable only as additional safety in parks with continuous safety line (Coudou Pro).



22 kN 8 kN 80 g

ALU ALLOY - BENT GATE  
#266BD0400KK

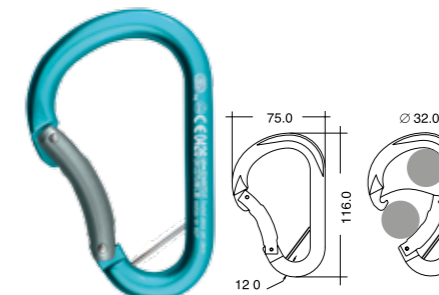

22 kN 8 kN 81 g

PADDLE BAR ALU ALLOY - BENT GATE  
#267BD0400KK



22 kN 8 kN 71 g

PADDLE WIRE ALU ALLOY - BENT GATE  
#901B00300KK

**WITH AUTOMATIC SAFETY GATE  
CON GHIERA DI SICUREZZA AUTOMATICA**

**FERRATA EX** #7780001G1KK

EN 12275/K - EN 362/B 30 kN 10 kN 90 g

- Alu alloy connector, Key Lock system, automatic express sleeve.
- Connettore in lega d'alluminio, sistema Key Lock e ghiera automatica Express.



**TANGO** #71500NNX2KK

EN 12275/K - EN 362/B 33 kN 12 kN 123 g

- Alu alloy connector, Key Lock system, double gate sleeve.
- Connettore in lega d'alluminio, sistema Key Lock e ghiera doppia sicurezza.



**WITHOUT SAFETY GATE  
SENZA GHIERA DI SICUREZZA**

- Utilizzabile solo come sicurezza aggiuntiva nei parchi con linea vita continua (Coudou Pro).

SLINGS  
FETTUCCE

## Y ARO ADVENTURE

#276V085R0KK (85 cm) EN 958  
#276V100R2KK (100 cm)

- "Y" longe for connectors.
- On request, for suitable minimum quantities, we can assess custom length.
- Longe a "Y" per connettori.
- Su richiesta, per quantitativi minimi idonei, è possibile valutare lunghezze personalizzate.

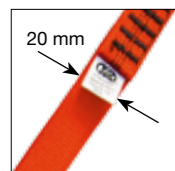

## ARO ADVENTURE

#275V0505WKK (50 cm) EN 958  
#275V0600WKK (60 cm)  
#275V0800OKK (80 cm)

- Single longe for connectors.
- On request, for suitable minimum quantities, we can assess custom length.
- Longe singola per connettori.
- Su richiesta, per quantitativi minimi idonei, è possibile valutare lunghezze personalizzate.

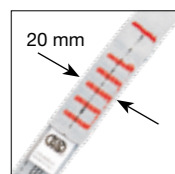

## DOUBLE ARO ADVENTURE

#282V040N0KK (40 cm) EN 566  
#282V05200KK (52 cm)

- Double lark's foot longe to combine pulley and harness.
- Length 52 cm (adults), 40 cm (kids). Other lengths on request.
- Longe con doppia asola per bocca di lupo, per collegare la carrucola all'imbrago.
- Lunghezza 52 cm (adulti), 40 cm (bambini). Altre misure a richiesta.

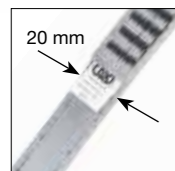

EVACUATION KIT  
KIT EVACUAZIONE

## STATIC LANYARD #278SETL06KK

EN 354 - EN 358 - EN 566 - EN 795/B

- Static rope with loops, length 25m, fitted with connector.
- Other length on request.
- Corda statica asolata, lunghezza 25m, dotata di connettore.
- Altre lunghezze su richiesta.



## X-LARGE #411120ZZZKK

EN 12275/H - EN 362/B

◀ 50 kN ▶ 13 kN ▲ 240 g

- 2 carbon steel connectors, fitted with Key Lock system and automatic Twist Lock sleeve (two movements).
- 2 connettori in acciaio, sistema Key Lock e ghiera automatica Twist Lock a due movimenti.



## INDY EVO #801020400KK

EN 341/2A - EN 12841/C

- Descender device certified for two people.
- It allows to take in slack the rope.
- Discensore a freno, omologato per due persone.
- Permette la risalita su corda.



## WIRE STEEL ROPE #277M00100KK

EN 354 - EN 358 - EN 795/B

- No-cut lanyard with loops and thimbles, 1 meter length.
- Other length on request.
- Longe antitaglio con due asole con redance, lunghezza 1 metro.
- Altre lunghezze su richiesta.



## TRIMMER SET TANGO

EN 358

#289SETU01KK (2 m)  
#289SETU02KK (3 m)  
#289SETU04KK (4 m)  
#289SETU04KK (5 m)

- TRIMMER adjustable lanyard is used to realize work positioning systems in conjunction with a fall arrest device. Enables quick and accurate adjustment of the length for the best positioning at the work station.
- Other sizes and connectors on request.
- TRIMMER è utilizzato per realizzare sistemi di posizionamento sul lavoro in abbinamento ad un dispositivo anticaduta. Consente la regolazione rapida e precisa della lunghezza necessaria in base alle condizioni del posto di lavoro per un posizionamento ideale.
- Altre misure e altri connettori su richiesta

**Other sizes and connectors on request**  
Altre misure e altri connettori su richiesta



## ARO BULL #280A060R0KK

EN 354 - EN 566 - EN 795/B

- Polyamide heavy load ring with stress indicator.
- Anello in fettuccia in Poliammide ad alto carico con spia di usura.



▶ 35 kN

## CUTTER #954020000KK

- Shear for cutting of the rope.
- Cesoa per il taglio delle funi.



## K-BLADE #954030000KK

- Professional knife ideal for work at height and rescue situations.
- Coltello professionale ideale per le situazioni di lavoro in quota e soccorso.



## MINI HOIST #208001000KK

- Emergency hoist that allows to lift a load reducing to 1/3 the force required.
- The best choice during evacuation maneuvers avoiding the cut of the rope.
- Paranco che permette di recuperare il carico riducendo a un terzo la forza necessaria.
- La scelta ideale per effettuare le manovre di evacuazione evitando il taglio della corda.



## ROPE BAG 100 #982501000KK

- Bag for the carriage of the kit fitted with suspension loop and shoulder straps.
- Capacity 28 liters.
- Sacco per il trasporto del kit dotato di gancio per la sospensione e spallacci per il trasporto a spalla.
- Capacità 28 litri.



ph: parco Jungle Rider Park, Civenna (LC)



**KONG s.p.a.**

Via XXV Aprile, 4 - (zona industriale)

I - 23804 MONTE MARENZO (LC) - ITALY

Tel +39 0341630506 - Fax +39 0341641550

info@kong.it

**www.kong.it**

ACROBATIC PARKS 2017 - EN/IT



8 023577 052137